

Inscribed Angles

© 2012 Kuta Software LLC. All rights reserved.

Solve for x .

1)

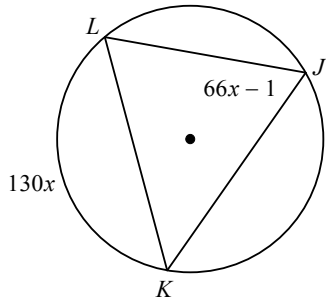

2)

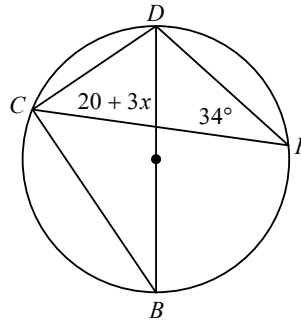

3)

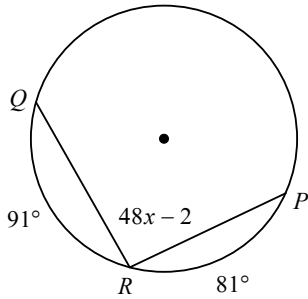

4)

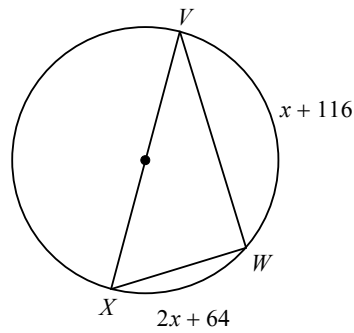

5)

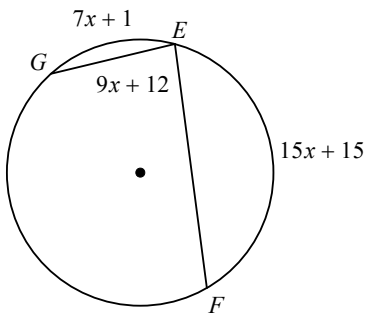

6)

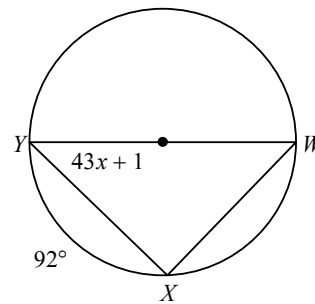

7)

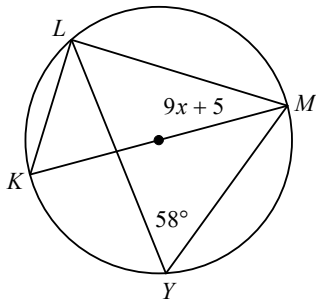

8)

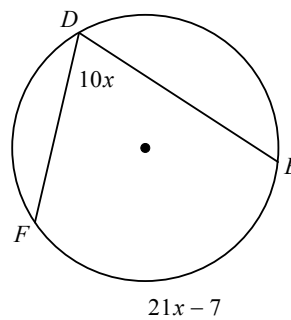

9)

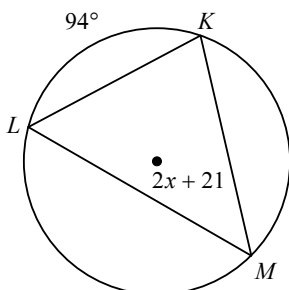

10)

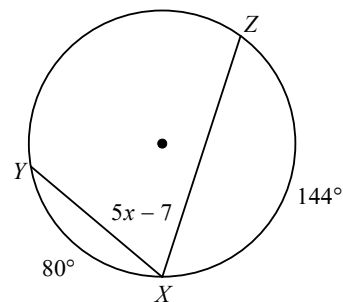

11)

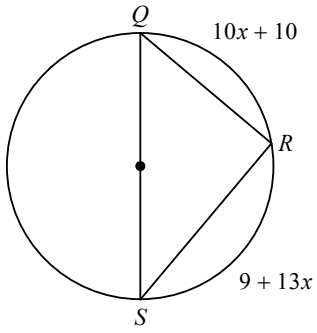

12)

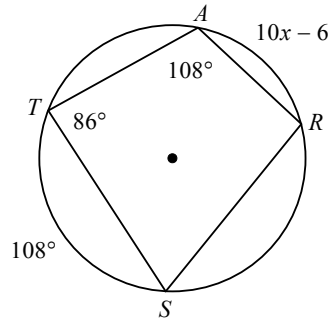

13)

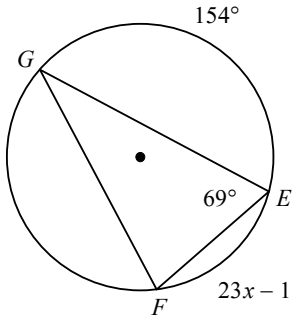

14)

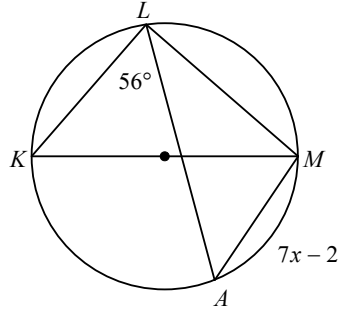

15)

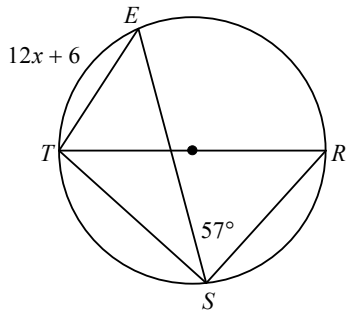

16)

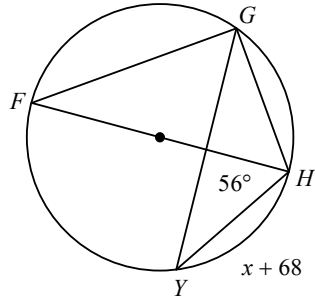

17)

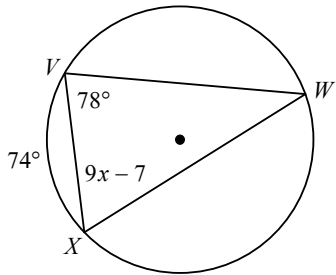

18)

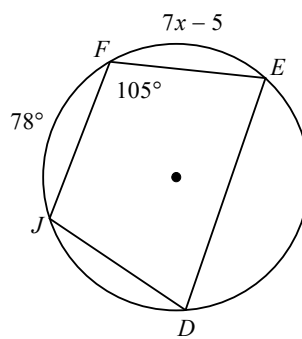

19)

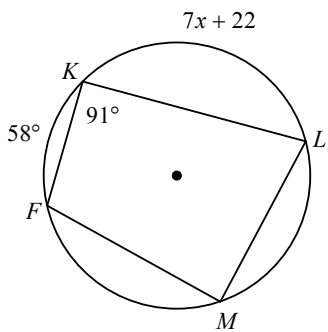

20)

